

## FAT THOR

1st pass  
 13-october-05  
 inspired by diyAudio.com  
 drawn by dld

"pedestal" required to lift terminus  
 free (and raise tweeter closer to  
 listening level)

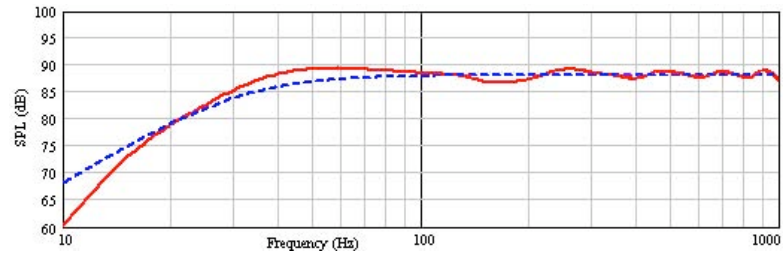

## FAT THOR ML

19-november-05  
 updated: 06-november-07  
 inspired by diyAudio.com  
 tweaked by Scottmoose  
 drawn by did

Placement of brace (just off centre). Notch the brace to accommodate the drivers. Mid-woofer magnets should fit tightly to notch. Brace needs to be filled with random holes with the goal of 35-50% open space.

optional additional bracing (just off centre). Brace needs to be filled with random holes with the goal of 35-50% open space.

"pedestal" required to lift terminus free (and raise tweeter closer to listening level) or run the port out the back or side

### NOTES:

- 1/ drawn with 3/4" (19mm) material
- 2/ 0.75 lbs / ft<sup>3</sup> (12 g / litre)
- 3/ 3" D, 4" long port (75mm x 102mm)
- 4/ corner reflectors non-critical

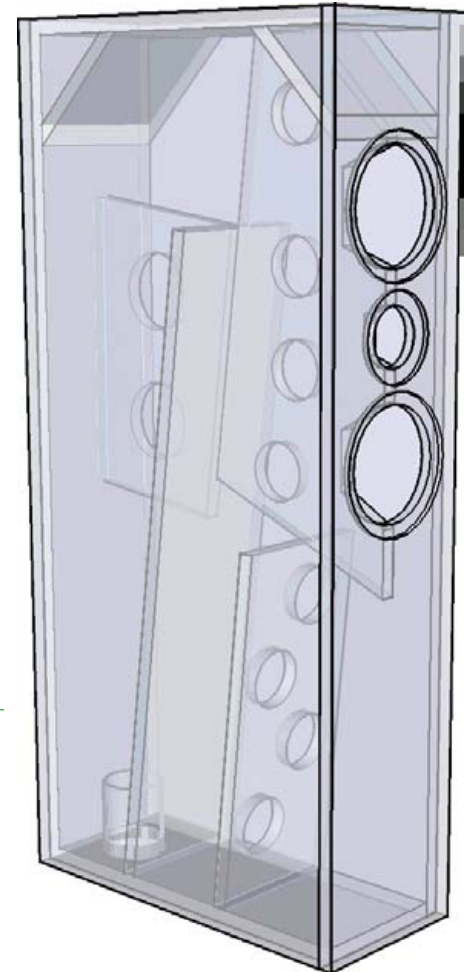
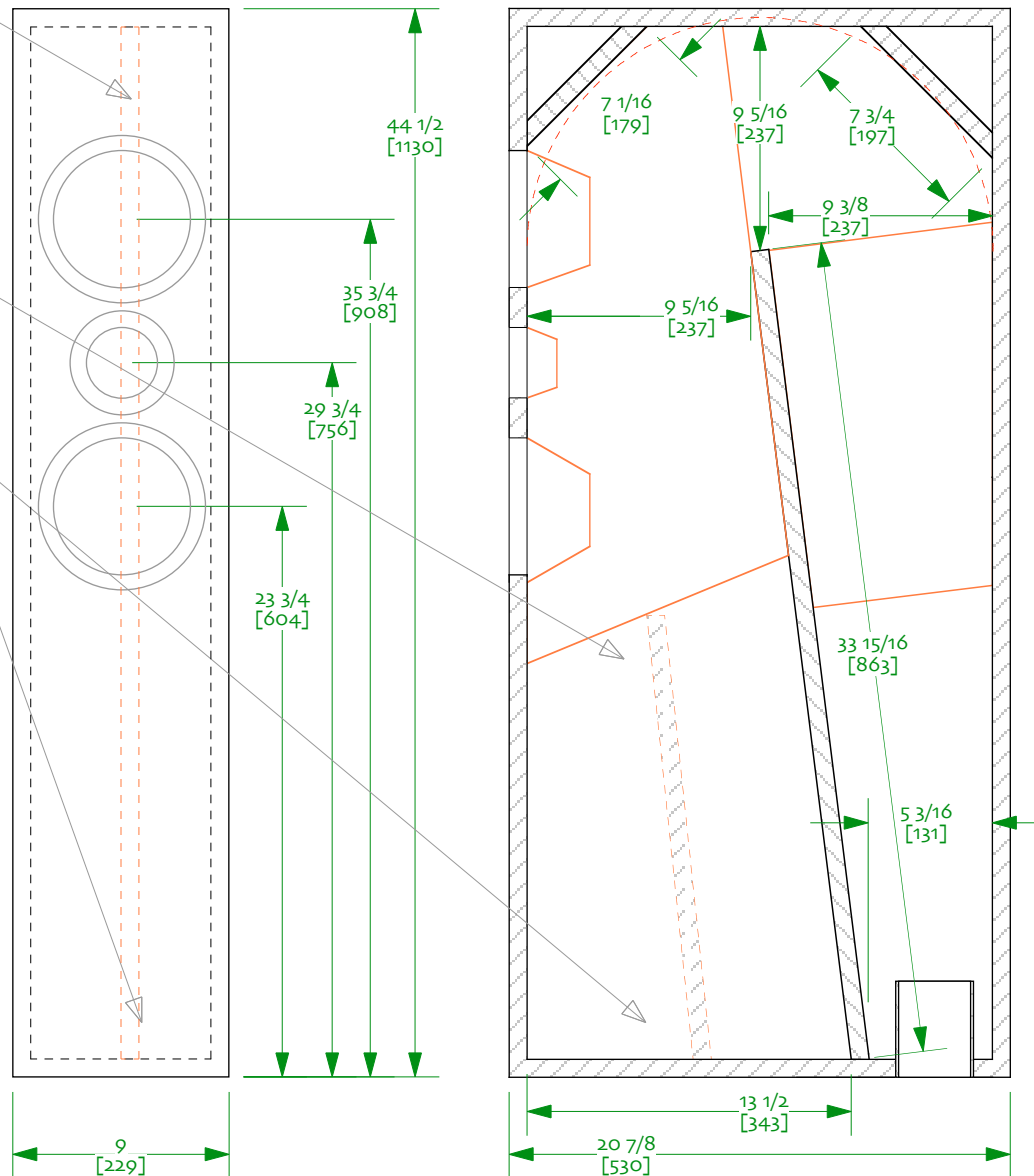

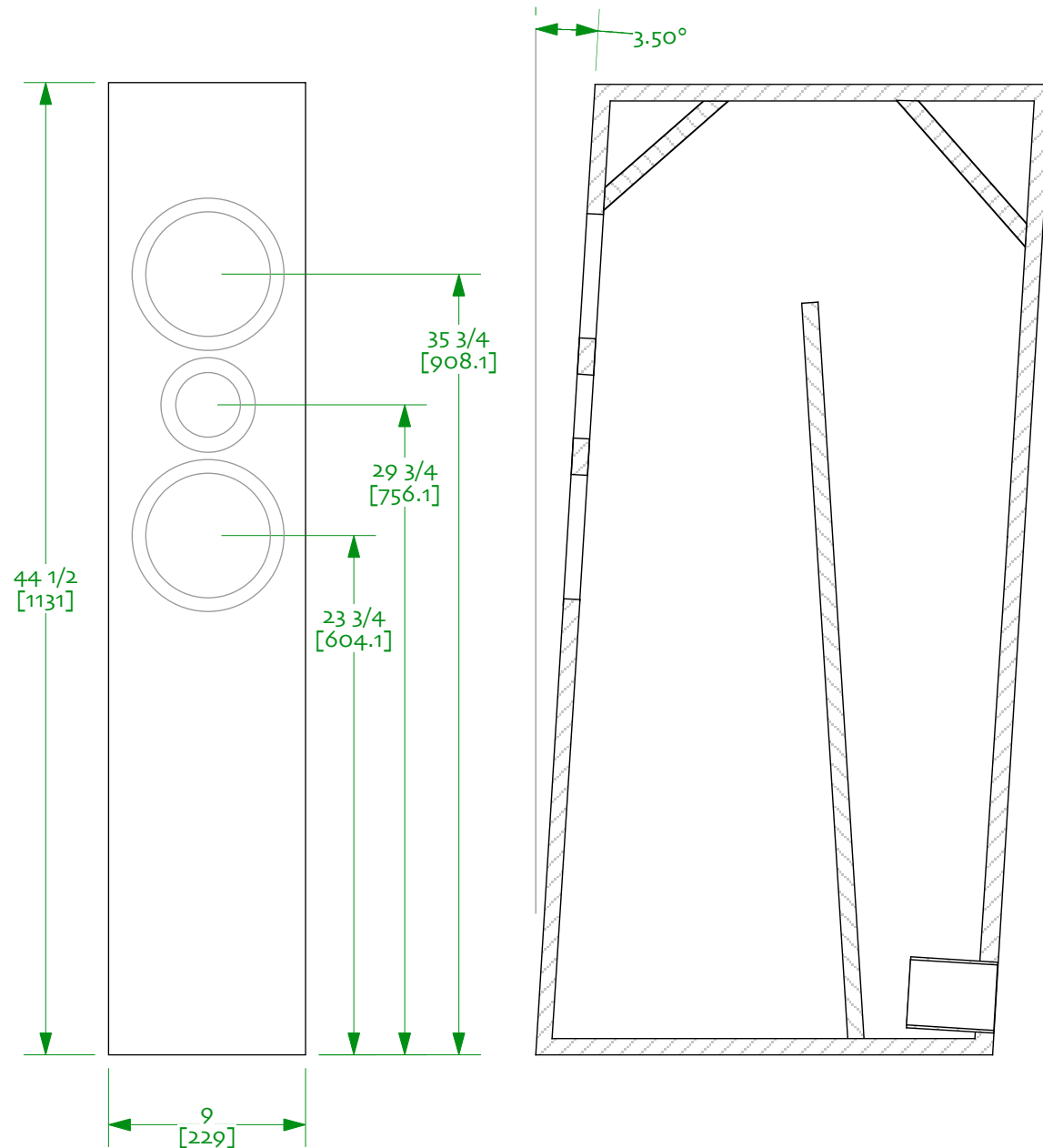

## FAT THOR ML

Trapezoidal Variation

14-october-05

inspired by diyAudio.com

tweaked by Scottmoose

drawn by dld

# SHORT THOR ML-TL

15-october-05 / updated 07-nov-07  
 inspired by diyAudio.com  
 designed by Scottmoose  
 drawn by dld

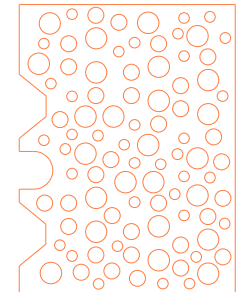
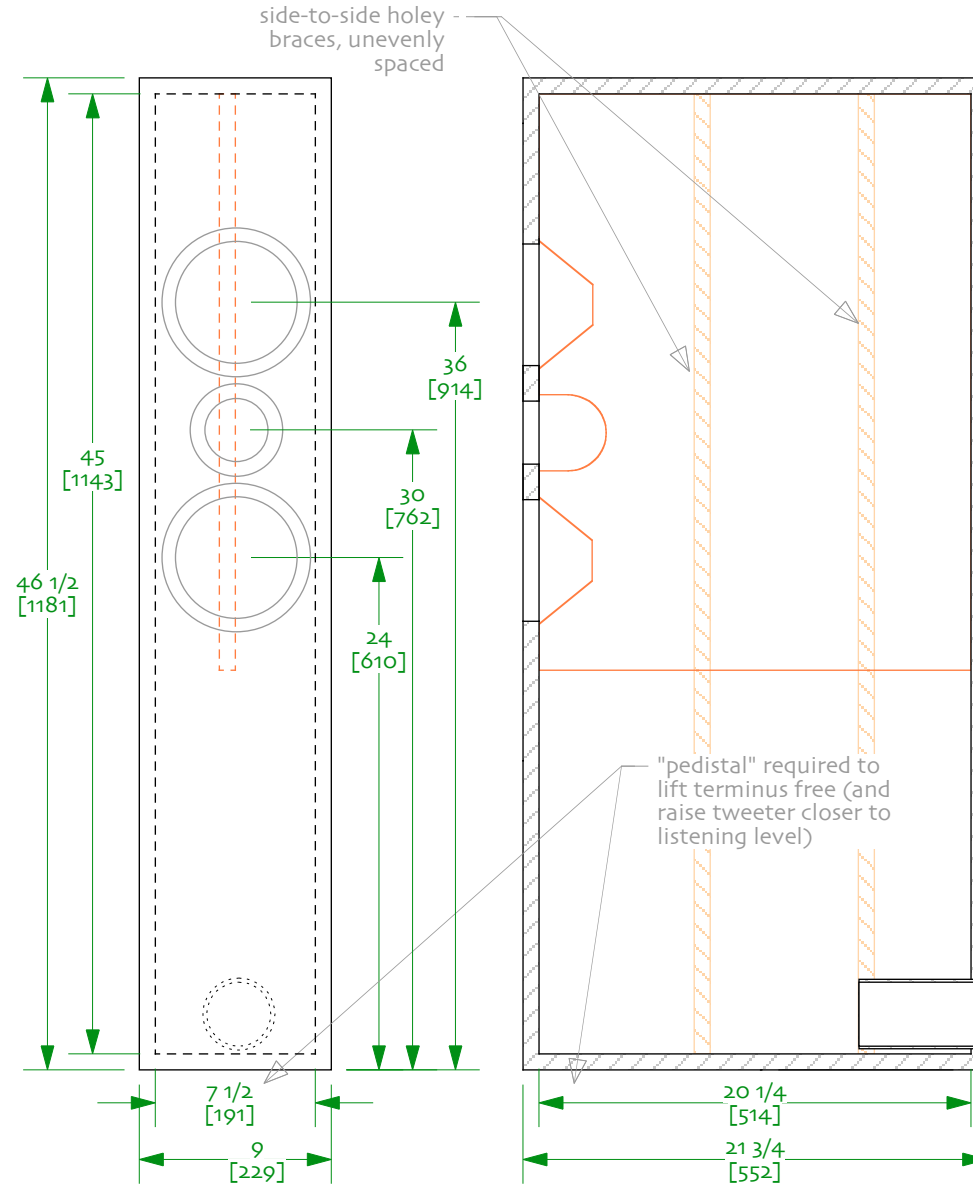
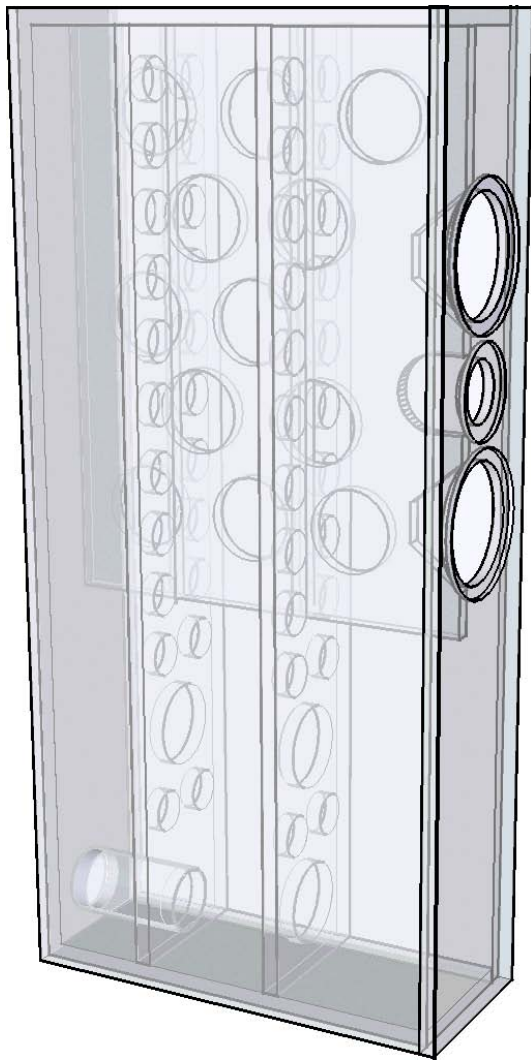

## NOTES:

- 1/ drawn with 3/4" (19mm) material
- 2/ 0.5 lbs / ft<sup>3</sup> (8 g /litre). Stuff from the top to the half-way mark, or just past
- 3/ 3" D, 6" long port (75mm x 152mm)
- 4/ swiss cheese bracing as above.
- 5/ 3/4" (19mm) brace front-to-back couples the midbasses to the cabinet back, top, & side-to-side braces.
- 6/ side-to-side are irregularly spaced using golden ratio. Diagonal is even better
- 7/ port can be moved to the front or bottom

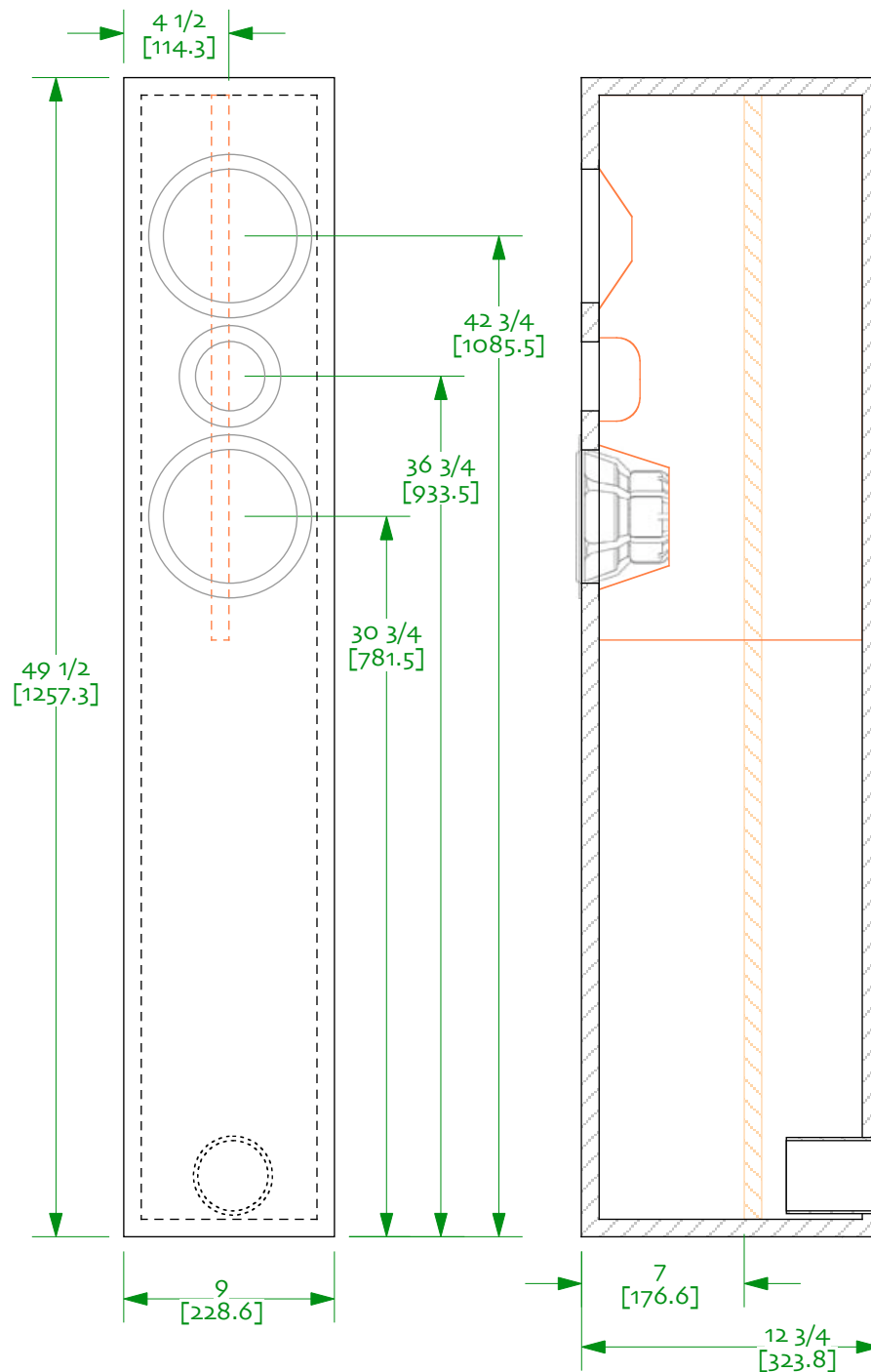

## SMALL THOR ML-TL

27-april-06  
inspired by diyAudio.com  
designed by Scottmoose  
drawn by dld

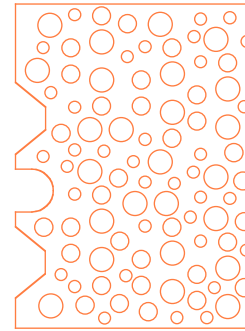

### NOTES:

1/ drawn with  $\frac{3}{4}$ " (19mm) material

2/ 0.5 lbs / ft<sup>3</sup> (8 g / litre). Stuff from the top to the half-way mark, or just past

3/  $\frac{3}{3}$ " D, 4" long port (75mm x 102mm)

4/ swiss cheese bracing as above.

5/  $\frac{3}{4}$ " (19mm) brace front-to-back couples the midbasses to cabinet back, top, & side-to-side brace.

6/ side-to-side are irregularly spaced using golden ratio. Diagonal is even better

7/ port can be moved to the front or bottom

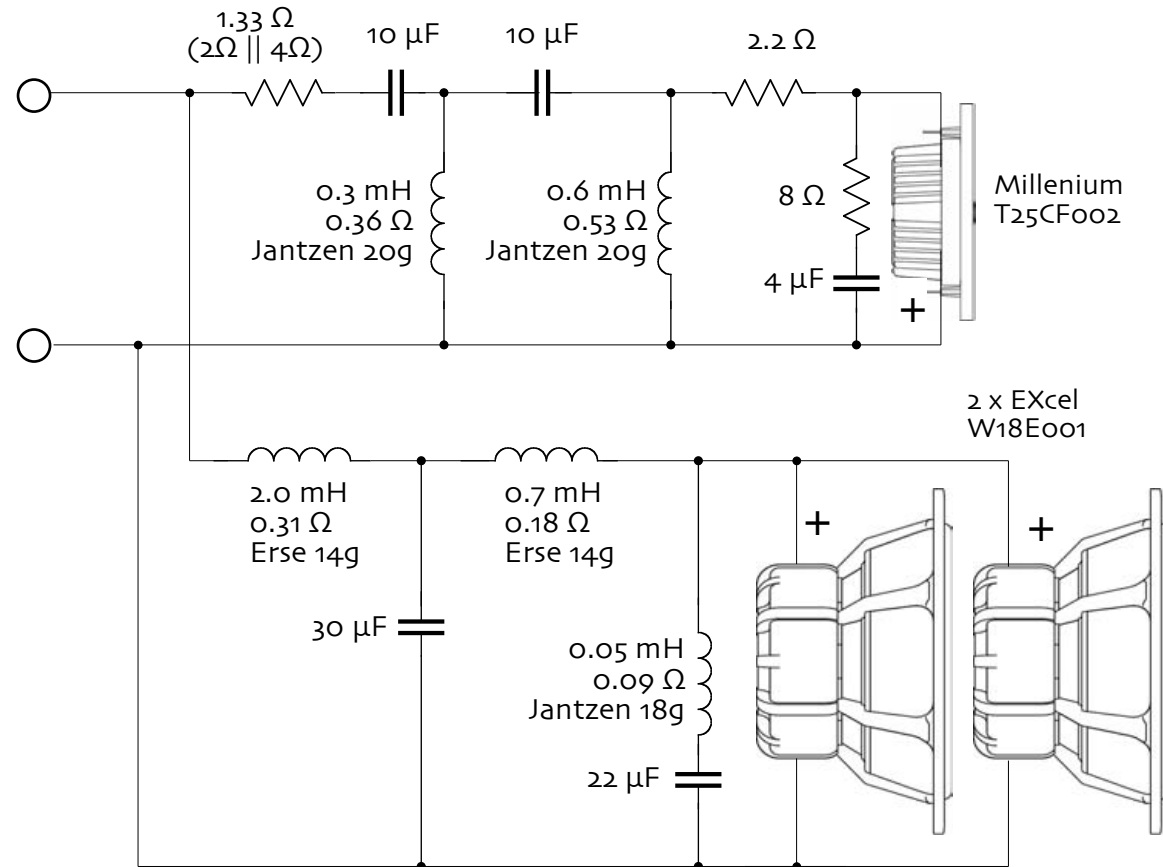

### SEAS MTM Crossover drivers as used in Thor/Odin

Note: bafflestep for 10" baffle width (a full 6 dB is implemented)  
 see <<http://www.htguide.com/forum/showthread.php4?t=26754>> for more info  
 designed by jimangie1973  
 drawn by dld / 04-september-2007

A revised version exists